



INTERFACE CONTROL DOCUMENT

WINGTIP PSL SYSTEM

Aviation model	Description	Part number
WPSL14R	WINGTIP RED & WHITE POSITION/STROBE LIGHT 14V	6490611 AMD(0)
WPSL14G	WINGTIP GREEN & WHITE POSITION/STROBE LIGHT 14V	6490621 AMD(0)
WPSL28R	WINGTIP RED & WHITE POSITION/STROBE LIGHT 28V	6490711 AMD(0)
WPSL28G	WINGTIP GREEN & WHITE POSITION/STROBE LIGHT 28V	6490721 AMD(0)

CS-ETSO-C30d for Position Light Function
CS-ETSO C96b for Strobe Light Function



Diffusion	Interne à JPC			Externe à JPC	
	1 ex → RAQ			1 ex → EASA	
Version	Document	Issue	Date	Last evolution	Pages changed
	649 06&07 11&21 ICD 01	2	29/03/2022	See page 2	All
Visas	Author : Julien BONNEAU		Technical : Pierre JACQUIER		Approbation : Christian ESCOTO
					

Table of contents

<u>1</u>	<u>General</u>	<u>4</u>
<u>1.1</u>	<u>Generalities</u>	<u>4</u>
<u>1.2</u>	<u>Destination</u>	<u>4</u>
<u>1.3</u>	<u>Related documents</u>	<u>4</u>
<u>1.4</u>	<u>Description</u>	<u>4</u>
1.4.1	Wingtip Red & White Position/Strobe Light	5
1.4.2	Wingtip Green & White Position/Strobe Light	5
<u>2</u>	<u>Mechanical interfaces</u>	<u>6</u>
<u>2.1</u>	<u>Equipment outlines</u>	<u>6</u>
<u>2.2</u>	<u>Mounting</u>	<u>6</u>
<u>3</u>	<u>Optical features</u>	<u>6</u>
<u>3.1</u>	<u>Red position light function (P/N 6480611 & 6490711)</u>	<u>6</u>
<u>3.2</u>	<u>Green position light function (P/N 6480621 & 6490721)</u>	<u>7</u>
<u>3.3</u>	<u>White position light function (P/N 6480611, 6490721, 6490711 & 6490721)</u>	<u>8</u>
<u>3.4</u>	<u>Strobe light function (P/N 6480611, 6490721, 6490711 & 6490721)</u>	<u>9</u>
<u>3.5</u>	<u>Operating temperature</u>	<u>9</u>
<u>4</u>	<u>Electrical interfaces</u>	<u>10</u>
<u>4.1</u>	<u>Power supply interface</u>	<u>10</u>
4.1.1	Wingtip Red & White Position/Strobe Light P/N 6490611 and Wingtip Green & White Position/Strobe Light P/N 6490621 - 14VDC	10
4.1.2	Wingtip Red & White Position/Strobe Light P/N 6490711 and Wingtip Green & White Position/Strobe Light P/N 6490721 - 28VDC	10
<u>4.2</u>	<u>Power dissipation</u>	<u>11</u>
<u>4.3</u>	<u>Signals and wires definition</u>	<u>11</u>
<u>4.4</u>	<u>Grounding and bonding</u>	<u>11</u>
<u>5</u>	<u>Installation procedure</u>	<u>12</u>
<u>6</u>	<u>Periodic Inspections</u>	<u>13</u>
<u>7</u>	<u>Annex 1 - 3D views</u>	<u>14</u>
<u>7.1</u>	<u>Wingtip Red & White Position/Strobe Light</u>	<u>14</u>
<u>7.2</u>	<u>Wingtip Green & White Position/Strobe Light</u>	<u>14</u>
<u>8</u>	<u>Annex 2 – 2D drawing</u>	<u>15</u>

1 General

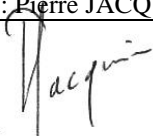
1.1 Generalities

This document defines the electrical, mechanical and thermal interfaces for WINGTIP PSL SYSTEM.

Aviation model	Description	Part number
WPSL14R	WINGTIP RED & WHITE POSITION/STROBE LIGHT 14V	6490611 AMD(0)
WPSL14G	WINGTIP GREEN & WHITE POSITION/STROBE LIGHT 14V	6490621 AMD(0)
WPSL28R	WINGTIP RED & WHITE POSITION/STROBE LIGHT 28V	6490711 AMD(0)
WPSL28G	WINGTIP GREEN & WHITE POSITION/STROBE LIGHT 28V	6490721 AMD(0)

1.2 Destination

Fixed wing aircraft.

1.3 Related documents

See last evolution of Design & Description File 649 06&07 11&21 DF 01.

1.4 Description

Wingtip Led Position & Strobe Lights include in the same casing forward position light, rear position light and strobe light.

A system is composed by 1 x WINGTIP RED & WHITE POSITION/STROBE LIGHT and 1 x WINGTIP GREEN & WHITE POSITION/STROBE LIGHT:

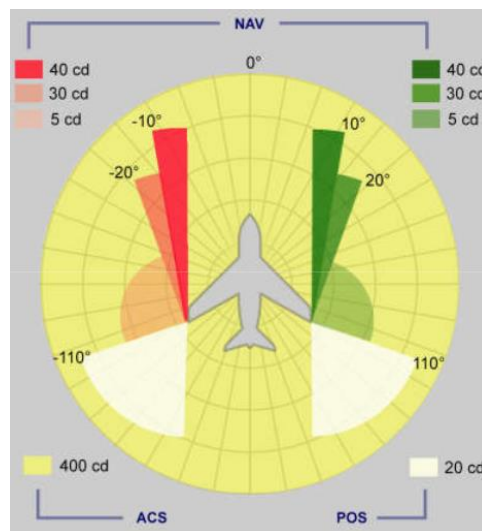

Forward position lights are aviation red or aviation green color with performances according to CS-ETSO-C30d requirements (SAE AS 8037 REV C Position Light Systems).

Rear position light is aviation white color with performances according to CS-ETSO-C30d requirements (SAE AS 8037 REV C Position Light Systems).

Strobe light is aviation white color with performances according to CS-ETSO-C96b requirements (SAE AS 8017 REV C Anticollision Light Systems).

Wingtip Led Position & Strobe Lights are purposed for 14VDC or 28VDC installation (different part numbers).

Wingtip Led Position & Strobe Lights are a variant of our Led Positions Light system certifies ETSO, Led Anticollision Light system certifies ETSO, or qualified on helicopters for AIRBUS HELICOPTERS, with the same design rules and same no complex electronic system and no EMC interferences. It offers an extremely high reliability, a high resistance to shocks and vibration.

Positive points of those new equipment:

- Up to 20.000 hours MTBF.
- Self-contained system (electronic regulation and led light included in the same casing)
- Independent power supply for position light system and anticollision light (2 separated board)
- Low weight.

The lens is made in anti UV polycarbonate, similar than already used and qualified on ETSO certified anticollision lights.

Mechanical parts are made in aluminum with SURTEC 650 protection.

1.4.1 Wingtip Red & White Position/Strobe Light

Position light function:

Red light source: 6 x red power LED assembled on 8/10 FR4 PC board with thermal via.

White light source: 2 x white power LED assembled on 8/10 FR4 PC board with thermal via.

Electronic current driver is [located on Position light regulation board. Dedicated electronic board independent of Strobe light regulation board, with dedicated power input.](#)

[Led driver: Analogic PWM current regulation. Reuse of simple architecture used in ETSO certified position lights, with no complex electronic.](#)

Strobe light function:

White light source: 30 x white power LED assembled on 8/10 FR4 PC board with thermal via.

Electronic current driver is [located on Strobe light regulation board. Dedicated electronic board independent of Position light regulation board, with dedicated power input.](#)

[Led driver: Linear current regulation. Reuse of simple architecture used in certified anticollision lights for helicopters, with no complex electronic.](#)

[Led flashing: CMOS analogic timer, analogic pulse generator.](#)

1.4.2 Wingtip Green & White Position/Strobe Light

Position light function:

Green light source: 4 x green power LED assembled on 8/10 FR4 PC board with thermal via.

White light source: 2 x white power LED assembled on 8/10 FR4 PC board with thermal via.

Electronic current driver is [located on Position light regulation board. Dedicated electronic board independent of Strobe light regulation board, with dedicated power input.](#)

[Led driver: Analogic PWM current regulation. Reuse of simple architecture used in ETSO certified position lights, with no complex electronic.](#)

Strobe light function:

White light source: 30 x white power LED assembled on 8/10 FR4 PC board with thermal via.

Electronic current driver is [located on Strobe light regulation board. Dedicated electronic board independent of Position light regulation board, with dedicated power input.](#)

[Led driver: Linear current regulation. Reuse of simple architecture used in certified anticollision lights for helicopters, with no complex electronic.](#)

[Led flashing: CMOS analogic timer, analogic pulse generator.](#)

2 Mechanical interfaces

2.1 Equipment outlines

Same physical characteristic for Wingtip Red & White Position/Strobe Light and Green & Wingtip Green & White Position/Strobe Light

- Aluminum 2017 + SURTEC 650 treatment

Lens: polycarbonate with “UV” protection.

- Dimension: (see 2D drawing in annex)

Height	: 50.8 mm +/- 1
Length	: 142.6 mm +/- 0.5
Width	: 42.7 mm +/- 0.5
Weight	: 210 g +/- 10 %

2.2 Mounting

See interface drawing in annex.

3 Optical features

3.1 Red position light function (P/N 6480611 & 6490711)

Light source description:

SMI aluminum printed circuit board.

6 high power red/orange LED CREE XP-E2.

Diffusion angle: 120° - Luminous flux: 107 lumens at 350 mA.

LED forwarding current: 150 mA.

Light Intensity:

Test performed on a mockup.

Horizontal plan:

$0^\circ < x < 10^\circ$	$I \geq$ to 40 cd at 25°C & after T° stabilization
$10^\circ < x < 20^\circ$	$I \geq$ to 30 cd at 25°C & after T° stabilization
$20^\circ < x < 110^\circ$	$I \geq$ to 5 cd at 25°C & after T° stabilization

Vertical plan:

0°	$1.00 \times I$ at 25°C & after T° stabilization
$0^\circ < x \leq 5^\circ$	\geq to 0.90 x I at 25°C & after T° stabilization
$5^\circ < x < 10^\circ$	\geq to 0.80 x I at 25°C & after T° stabilization
$10^\circ < x \leq 15^\circ$	\geq to 0.70 x I at 25°C & after T° stabilization
$15^\circ < x < 20^\circ$	\geq to 0.50 x I at 25°C & after T° stabilization
$20^\circ < x \leq 30^\circ$	\geq to 0.30 x I at 25°C & after T° stabilization
$30^\circ < x \leq 40^\circ$	\geq to 0.10 x I at 25°C & after T° stabilization
$40^\circ < x \leq 90^\circ$	\geq to 0.05 x I at 25°C & after T° stabilization

Light source view:

Red side (front view)

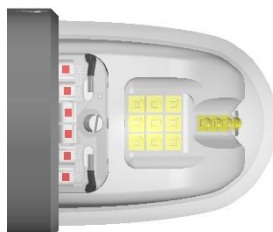

3.2 Green position light function (P/N 6480621 & 6490721)

Light source description:

SMI aluminum printed circuit board.

4 high power green LED CREE XP-E2.

Diffusion angle: 120° - Luminous flux: 122 lumens at 350 mA.

LED forwarding current: 150 mA.

Light Intensity:

Test performed on a mockup.

Horizontal plan:

<u>$0^\circ < x < 10^\circ$</u>	<u>$I > \text{to } 40 \text{ cd at } 25^\circ\text{C \& after } T^\circ \text{ stabilization}$</u>
<u>$10^\circ < x < 20^\circ$</u>	<u>$I > \text{to } 30 \text{ cd at } 25^\circ\text{C \& after } T^\circ \text{ stabilization}$</u>
<u>$20^\circ < x < 110^\circ$</u>	<u>$I > \text{to } 5 \text{ cd at } 25^\circ\text{C \& after } T^\circ \text{ stabilization}$</u>

Vertical plan:

<u>0°</u>	<u>$1.00 \times I \text{ at } 25^\circ\text{C \& after } T^\circ \text{ stabilization}$</u>
<u>$0^\circ < x < 5^\circ$</u>	<u>$\geq \text{to } 0.90 \times I \text{ at } 25^\circ\text{C \& after } T^\circ \text{ stabilization}$</u>
<u>$5^\circ < x < 10^\circ$</u>	<u>$\geq \text{to } 0.80 \times I \text{ at } 25^\circ\text{C \& after } T^\circ \text{ stabilization}$</u>
<u>$10^\circ < x < 15^\circ$</u>	<u>$\geq \text{to } 0.70 \times I \text{ at } 25^\circ\text{C \& after } T^\circ \text{ stabilization}$</u>
<u>$15^\circ < x < 20^\circ$</u>	<u>$\geq \text{to } 0.50 \times I \text{ at } 25^\circ\text{C \& after } T^\circ \text{ stabilization}$</u>
<u>$20^\circ < x < 30^\circ$</u>	<u>$\geq \text{to } 0.30 \times I \text{ at } 25^\circ\text{C \& after } T^\circ \text{ stabilization}$</u>
<u>$30^\circ < x < 40^\circ$</u>	<u>$\geq \text{to } 0.10 \times I \text{ at } 25^\circ\text{C \& after } T^\circ \text{ stabilization}$</u>
<u>$40^\circ < x < 90^\circ$</u>	<u>$\geq \text{to } 0.05 \times I \text{ at } 25^\circ\text{C \& after } T^\circ \text{ stabilization}$</u>

Light source view:

Green side (front view)



3.3 White position light function (P/N 6480611, 6490721, 6490711 & 6490721)

Light source description:

FR4 printed circuit board.

2 high power white LED CREE XT-E into each position light.

Diffusion angle: 120° - Luminous flux:139 lumens at 350 mA and at 85°C.

LED forwarding current: 150 mA.

Light Intensity:

Test performed on a mockup.

Horizontal plan:

<u>$110^\circ < x \leq 180^\circ$</u>	<u>\geq to 20cd at 25°C & after T° stabilization</u>
---	---

Vertical plan:

<u>0°</u>	<u>$1.00 \times I$ at 25°C & after T° stabilization</u>
<u>$0^\circ < x \leq 5^\circ$</u>	<u>\geq to $0.90 \times I$ at 25°C & after T° stabilization</u>
<u>$5^\circ < x \leq 10^\circ$</u>	<u>\geq to $0.80 \times I$ at 25°C & after T° stabilization</u>
<u>$10^\circ < x \leq 15^\circ$</u>	<u>\geq to $0.70 \times I$ at 25°C & after T° stabilization</u>
<u>$15^\circ < x \leq 20^\circ$</u>	<u>\geq to $0.50 \times I$ at 25°C & after T° stabilization</u>
<u>$20^\circ < x \leq 30^\circ$</u>	<u>\geq to $0.30 \times I$ at 25°C & after T° stabilization</u>
<u>$30^\circ < x \leq 40^\circ$</u>	<u>\geq to $0.10 \times I$ at 25°C & after T° stabilization</u>
<u>$40^\circ < x \leq 90^\circ$</u>	<u>\geq to $0.05 \times I$ at 25°C & after T° stabilization</u>

Light source view:

White in red side

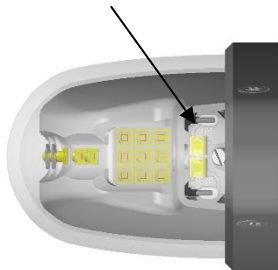

White in green side

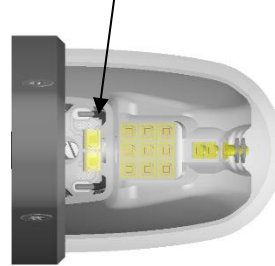

3.4 Strobe light function (P/N 6480611, 6490721, 6490711 & 6490721)

Note: A system is composed by 1 x WINGTIP RED & WHITE POSITION/STROBE LIGHT and 1 x WINGTIP GREEN & WHITE POSITION/STROBE LIGHT

Light source description:

FR4 printed circuit board.

30 high power white LED OSRAM SSL-80 into each light.

Diffusion angle: 80°

Luminous flux: 140 to 180 lumens (99 to 117 cd) at 350 mA and at 85°C.

LED forwarding current: 360 mA

Color: Cool White 5700°K to 6500°K.

Lights performances have been checked on a mockup in our photometric laboratory:

<u>Angle above & below horizontal plane</u>	<u>Ie (candle)</u>
<u>0° - 5°</u>	<u>≥ to 400 cd at 25°C & after T° stabilization</u>
<u>5° - 10°</u>	<u>≥ to 240 cd at 25°C & after T° stabilization</u>
<u>10° - 20°</u>	<u>≥ to 80 cd at 25°C & after T° stabilization</u>
<u>20° - 30°</u>	<u>≥ to 40 cd at 25°C & after T° stabilization</u>
<u>30° - 75°</u>	<u>≥ to 20 cd at 25°C & after T° stabilization</u>

3.5 Operating temperature

Positive temperature : +70 °C.

Negative temperature : - 45 °C.

4 Electrical interfaces

4.1 Power supply interface

4.1.1 Wingtip Red & White Position/Strobe Light P/N 6490611 and Wingtip Green & White Position/Strobe Light P/N 6490621 - **14VDC**

- Supply Voltage : Position light input : 11 to 32 V (PWM regulation)
Strobe light input : 14V (11 to 16 V)
- Current : Position light : 0.33 A with 14V input voltage
Strobe light : 3.5A peak during T“on”
1A average at 14VDC
- Power : Position light : 4.6 W
Strobe light : 14 W average
- LED forwarding current : Position light : 150 mA
Strobe light : 360 mA during T“on”
- Strobe Rating : [0.71](#) Hertz (+/- 5%)
- Strobe time ON : 1st flash : 250 ms
2nd flash : [65](#) ms

Performances In other situations (11V & 16V):

Position lights

Power supply level (in Volts)	Current	Performances
11 V	0.42 A	Preserved
14 V	0.33 A	Normal
16 V	0.29 A	Preserved

Strobe light:

Power supply level (in Volts)	Peak Current	Performances
11 V	3.5 A	Preserved
14 V	3.5 A	Normal
16 V	3.5 A	Preserved

4.1.2 Wingtip Red & White Position/Strobe Light P/N 6490711 and Wingtip Green & White Position/Strobe Light P/N 6490721 - **28VDC**

- Supply Voltage : Position light input : 11 to 32 V (PWM regulation)
Strobe light input : 28 V (22 to 32 V)
- Current : Position light : 0.18 A with 28V input voltage
Strobe light : 1.8A peak during T“on”
0.5A average at 28VDC
- Power : Position light : 5 W
Strobe light : 14 W average
- LED forwarding current : Position light : 150 mA
Strobe light : 360 mA during T“on”
- Strobe Rating : [0.71](#) Hertz (+/- 5%)
- Strobe time ON : 1st flash : 250 ms
2nd flash : [65](#) ms

Performances In other situations (24V & 32 V):

Position light

Power supply level (in Volts)	Peak Current	Performances
24 V	0.21 A	Preserved
28 V	0.18 A	Normal
32 V	0.16 A	Preserved

Strobe light

Power supply level (in Volts)	Peak Current	Performances
24 V	1.8 A	Preserved
28 V	1.8 A	Normal
32 V	1.8 A	Preserved

4.2 Power dissipation

Same characteristic for 14V or 28V Wingtip Light:

Operating Mode	Power dissipation MAX
OFF	0 W
ON Position Light	2.5 W
ON Strobe Light	3.6 W

4.3 Signals and wires definition

5 free end G22 wires	Red wire	:	+Vin position light
	Black wire	:	0V position light
	White wire	:	+Vin Strobe light
	blue wire	:	0V Strobe light
	Yellow wire	:	synchronization for 2 Strobe light

[No wire size length limitations between components.](#)

4.4 Grounding and bonding

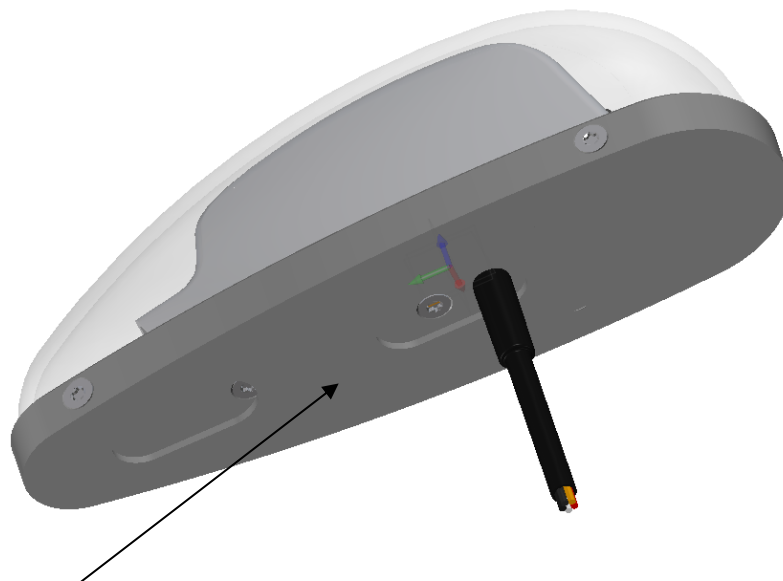

Bottom metalized area

5 Installation procedure

The following information provides guidelines for the installation of WINGTIP POSITION/STROBE LIGHT. Please refer to the OEM manual of the aircraft for specific removal and installation instructions.

- Prepare aircraft area with following interface drawing:

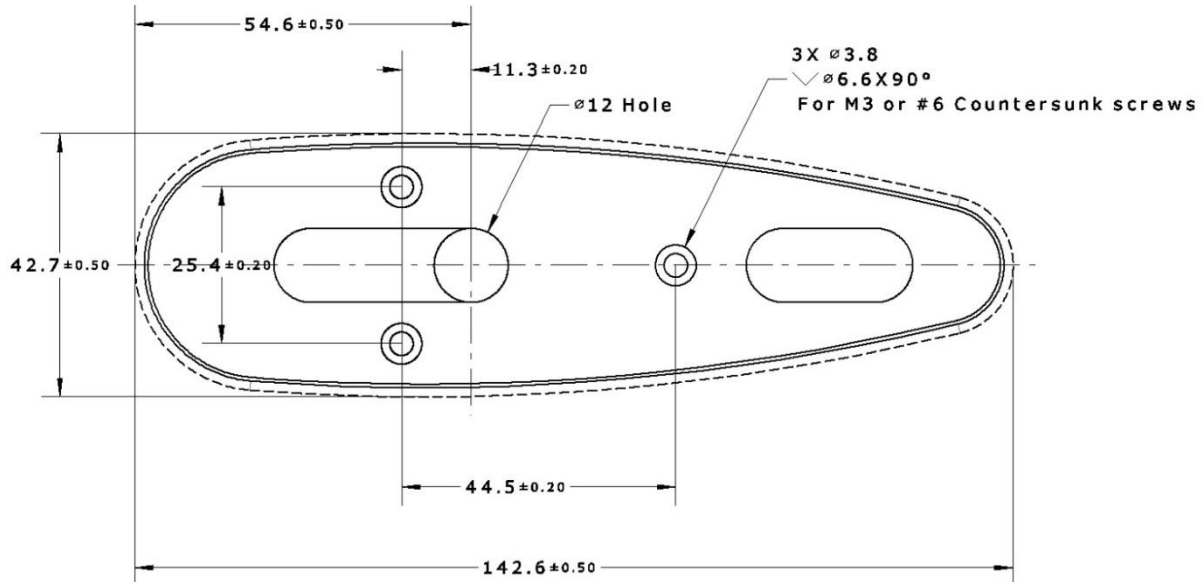

- Fix interface part with 3 x M3 or #6 countersunk screws (not provided)
- Connect the supply wires (see in §4.3) of the equipment.
- Plug equipment on interface part and lock with the 4 x TF M3x8 screws (provided) **without** thread locker.

Recommended torque: 1 Nm



6 Periodic Inspections

Every 100 hours or annually:

- Check that all LED are illuminated.
WARNING: Due to the high light intensity emitted by the equipment, it is recommended to wear eyes protection.

In case of LED failure, the equipment must be replaced [or repaired](#).

See documents reference:

649 06 11 CMM 01 last issue

649 06 21 CMM 01 last issue

649 07 11 CMM 01 last issue

649 07 21 CMM 01 last issue

- Check the lens aspect (absence of scratches or cracking). In case of presence of scratches or cracking on the glass, the equipment must be replaced or repaired.

Check the good state of the mechanical assembly and the electrical connections. In the case of a bad condition of the mechanical assembly or the electrical connection, they can be readjusted if they are not broken, otherwise the equipment must be replaced or repaired.

7 Annex 1 - 3D views

7.1 *Wingtip Red & White Position/Strobe Light*

Aviation Models: WPSL14R & WPSL28R
P/N: 6490611 AMD(0) & 6490711 AMD(0)



7.2 *Wingtip Green & White Position/Strobe Light*

Aviation Models: WPSL14G & WPSL28G
P/N: 6490621 AMD(0) & 6490721 AMD(0)



8 Annex 2 – 2D drawing

